

-

Stone No 5015059

Shape EMERALD

Real Weight 1.50 (Ct)

Width 5.37 (mm)

Length 7.41 (mm)

Total Height 69.75 (%) 3.740(mm)

Table 67.11 (%) 3.600(mm)

L/W Ratio 1.38

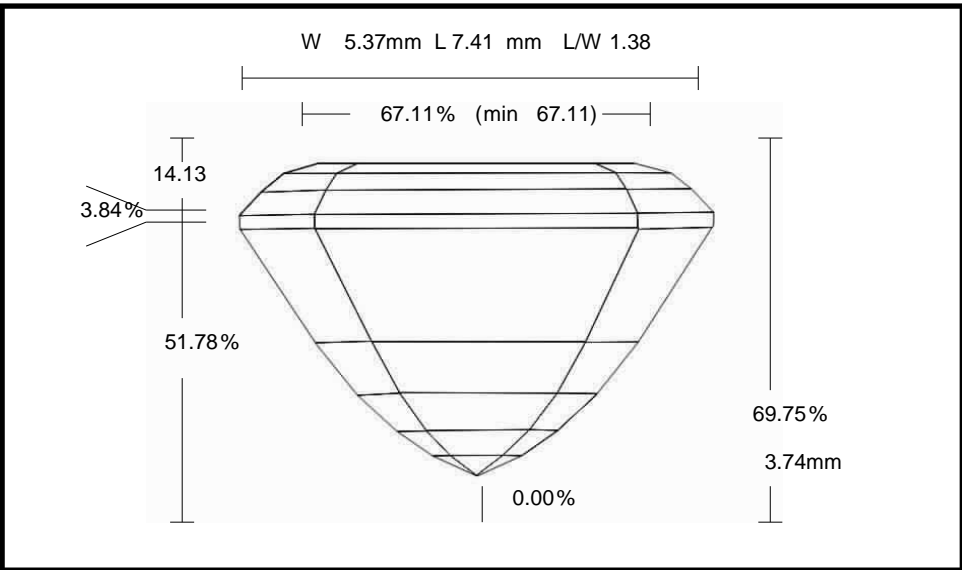

Parameter		Avg	Min	Max	Dev
Crown Angle 1	%	27.03	26.64	27.21	0.57
Crown Height	%	14.13	13.53	14.92	1.39
Girdle Thickness	%	3.84	3.44	4.15	0.71
Pavilion Angle 1 (Main)	%	62.31	62.08	62.78	0.70
Pavilion Height	%	51.78	51.18	52.13	0.95